

# TECNA®



Advanced Resistance Welding Systems and Balancers



## 3680

SISTEMA DI SALDATURA A RESISTENZA  
AUTOMATICO INVERTER PER CARROZZERIA

*AUTOMATIC, INVERTER RESISTANCE SPOT  
WELDING SYSTEM FOR CAR BODY SHOPS*

Spot welding solutions

[www.tecna.net](http://www.tecna.net)



IT



EN

# 3680

## TECNOLOGIA INNOVATIVA IN CARROZZERIA

## INNOVATIVE TECHNOLOGY IN THE BODY SHOP

1

Il trasformatore, interamente progettato e costruito da **TECNA**, è integrato nella pinza e raffreddato ad acqua in modo tale da massimizzare la produttività e **aumentare il "duty cycle"**.

*The welding transformer is fully designed and produced by **TECNA**. Integrated in the welding gun, it is fully water-cooled to optimize productivity and **increase the duty cycle**.*

2

Il sistema di raffreddamento ad acqua agisce su trasformatore, bracci ed elettrodi, con scambiatore di calore per aumentare ulteriormente la **produttività** della macchina.

*The water cooling system affects the transformer, the arms and the electrodes so to further increase the **productivity** of the equipment, through a heat exchanger.*

5

**Carrello ergonomico, compatto** e stabile; con apposito supporto bracci posteriore.

*The cart is ergonomic, compact and stable; it is provided with a proper arm-holder in the rear position.*

3

Braccio di sostegno con bilanciatore prodotto da **TECNA**, progettato e dimensionato per un **utilizzo confortevole e sicuro** in ambiente di lavoro.

*The supporting arm includes a balancer produced by **TECNA**, designed and sized for a **safe and comfortable** operation in workshop environments.*

4

Nuovo controllo di saldatura touch screen con grafica intuitiva per un più semplice utilizzo della macchina da parte dell'operatore; possibilità di scelta tra modalità automatica **Smart+, Quick e Full**.

*New touch screen welding control unit with intuitive graphic diagrams, allowing a very simple use of the machine by the user. It is possible to choose between different operation modes: the automatic **Smart+, Quick and Full** mode.*

4

5

2

ART. ITEM 3680P7

# 3680

## DATI TECNICI

## TECHNICAL DATA



ART. ITEM 3680P



ART. ITEM 8679TS  
con sensore **Smart Plus** e forza max  
elettrodi **450 daN**

for **Smart Plus** mode  
and **450 daN** max.  
electrode force



ART. ITEM 8679TS7  
con sensore **Smart Plus** e forza max  
elettrodi **700 daN**

for **Smart Plus** mode  
and **700 daN** max.  
electrode force



Sistema di saldatura a resistenza, controllato a microprocessore, completamente automatico, adatto per applicazioni in carrozzeria. Il controllo di saldatura a display digitale con touch screen consente la visualizzazione ed il controllo di tutti i parametri di saldatura, in funzione degli utensili, del tipo e dello spessore delle lamiere da saldare.

Le principali caratteristiche del sistema di saldatura sono: il riconoscimento automatico della pinza di saldatura collegata; la pinza di saldatura con trasformatore integrato che permette il collegamento al sistema di saldatura tramite una presa industriale ed una serie di innesti rapidi, consentendone un'agevole sostituzione senza l'utilizzo di chiavi, utensili e viti. Pinza di saldatura, trasformatore, bracci ed elettrodi completamente raffreddati tramite un sistema di raffreddamento a circuito chiuso posizionato sul carrello del sistema stesso.

Resistance welding system controlled by a microprocessor; fully automatic, suitable for use in car body shop applications. The welding control unit uses a digital display with touch screen function and allows setting and monitoring all welding parameters according to the tools and according to the type and thickness of the sheets to be welded.

Briefly, the main features of this welding equipment can be summed up as follows: automatic identification of the connected welding gun; welding gun with integrated transformer enabling the connection to the welding system through an industrial socket and a set of quick fittings, thus allowing to avoid spanners, tools or screws for its replacement; welding gun main components i.e. transformer, arms, electrodes fully cooled by a closed loop cooling system, mounted on the cart of the system itself.

ART. - ITEM	3680P	3680P	3680P7	3680P7	
Tensione di rete - Supply voltage	*220	*400	*220	*400	V
Frequenza di rete - Mains frequency	50 / 60	50 / 60	50 / 60	50 / 60	Hz
Protezione di rete (ritardati) - Mains protection (delayed)	35-50	25-32	35-50	25-32	A
Pinza-Gun	8679TS		8679TS		
Potenza nominale 50% ED Nominal power 50% ED	19	19	19	19	kVA
Potenza massima di saldatura Maximum welding power	60	60	60	60	kVA
Corrente secondaria massima Maximum secondary current	14	14	14	14	kA
Corrente termica 100% Thermal current 100%	1,8	1,8	1,8	1,8	kA
Tensione a vuoto secondaria No load secondary voltage	8,7	8,7	8,7	8,7	V
Forza massima elettrodi Maximum electrode force	450	450	700	700	daN
Sensore di riconoscimento Recognition sensor	S	S	S	S	
Peso pinza Gun Weight	12,5	12,5	12,5	12,5	kg
Classe di protezione - Protection rating	21	21	21	21	IP
Peso - Weight	140	140	140	140	kg

S = Smart Plus

\* Altre tensioni a richiesta - \* Different voltages on demand

# 3680

## CONTROLLO DI SALDATURA

## WELDING CONTROL UNIT

Nuovo controllo di saldatura touch screen con grafica intuitiva per un più semplice utilizzo della macchina da parte dell'operatore; possibilità di scelta tra modalità automatica **Smart+** che **riconosce il tipo di materiale e lo spessore e determina la corrente e la forza** ottimali per la saldatura; modalità **Quick** dove è sufficiente impostare **il tempo, la corrente e la forza**, quindi la modalità **Full** con possibilità di impostazione di tutti parametri di saldatura desiderati. **Interfaccia Usb** per esportare i dati da stampare relativi ai lavori di saldatura effettuati e per importare parametri di saldatura relativi a nuovi materiali, che **TECNA** abitualmente sviluppa in **collaborazione con i maggiori costruttori di auto**.

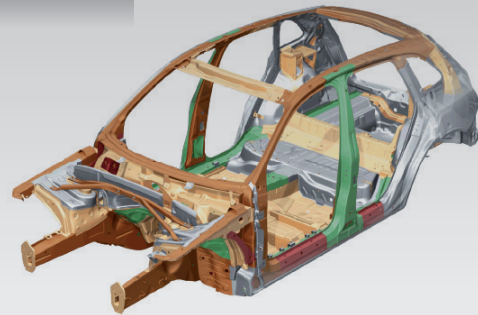

New touch screen welding control unit with intuitive graphic diagrams, allowing a very simple use of the machine by the user. It is possible to choose between different operation modes: the automatic **Smart+** mode recognizes the thickness and type of material thus automatically determining the **best values for current and force**, the **Quick** mode requiring to set **welding time, current and force** only, and the Full mode which allows a personal setting of all the desired welding parameters. A **USB interface** is available to easily export all data relevant to the performed welded spots for printing purposes. The same USB interface is used to update those welding parameters needed for new materials, parameters constantly developed by **TECNA** in **cooperation with the main car manufacturers**.



1. Modo Lavoro Smart+ - Working Mode: Smart+

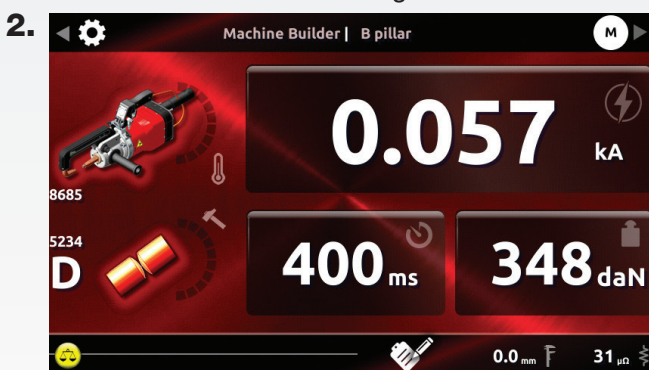

2. Modo Quick - Working Mode: Quick



3. Modo Lavoro Full - Working Mode: Full

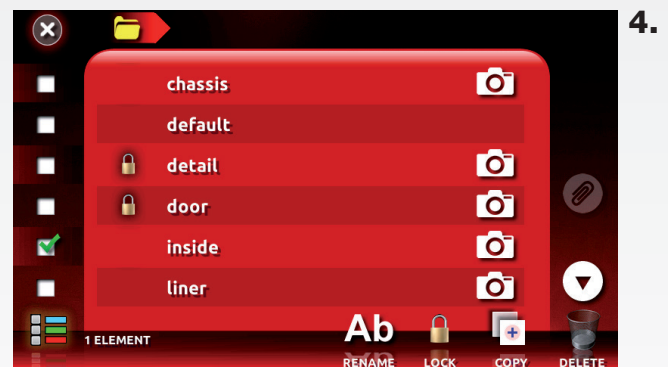



4. Modo Lavoro Full: Gestione Programmi - Working Mode: Full Management of Programs



5. Filtro su Punti - Filter on Spots

# SELEZIONE BRACCI, ELETTRODI E ACCESSORI

## SELECTION OF ARMS, ELECTRODES AND ACCESSORIES

-  ● ART. ITEM 5241- $\phi$ 16 / ART. ITEM 5228/7- $\phi$ 16
-  ● ART. ITEM 5242- $\phi$ 16 / ART. ITEM 5229/7- $\phi$ 16
-  ○ ART. ITEM 5230T- $\phi$ 16 / ART. ITEM 5230T/7- $\phi$ 16

ART. ITEM  
**Ø 16**



### ● ART. ITEM 8685/W/S

ART. ITEM 5227/W- $\phi$ 16 mm

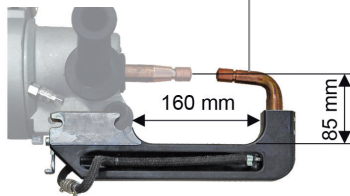

### ○ ART. ITEM 8684/W/S

ART. ITEM 5227/W- $\phi$ 16 mm

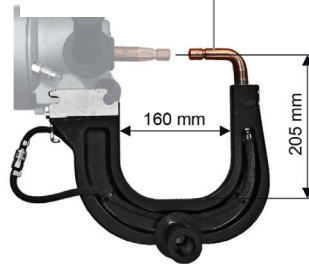

### ○ ART. ITEM 8686/W/S

ART. ITEM 5227/W- $\phi$ 16 mm

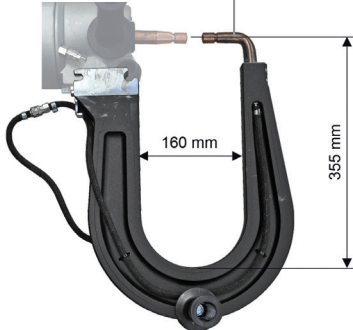

### ○ ART. ITEM 8690/W/S

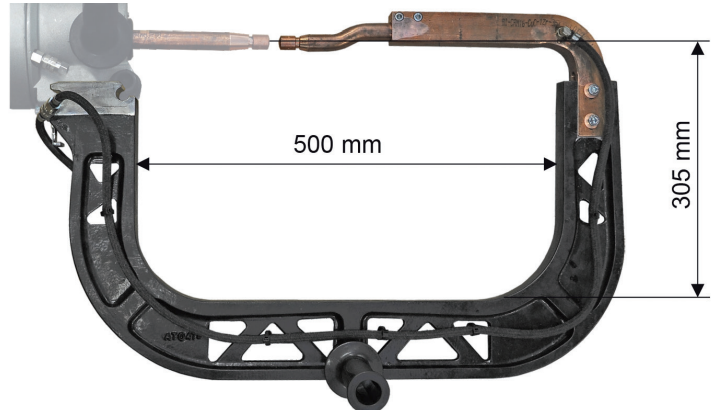

### ○ ART. ITEM 8689

ART. ITEM 5220/W

○ ART. ITEM 5241- $\phi$ 16mm

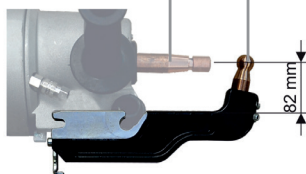

○ ART. ITEM 5221/2

○ ART. ITEM 5221/1

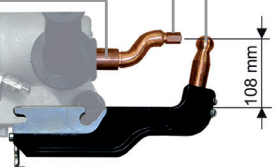

ART. ITEM 5220/W

OPZIONALI  
PER ART. 5221/2  
OPTIONAL  
FOR ITEM 5221/2

- 5210/C
- 5211/C
- 5213/C
- 5214/C
- 5218/C

## BRACCI PER - ARMS FOR 8679TS | 8679TS7

● STANDARD ○ A RICHIESTA - ON DEMAND

### ○ ART. ITEM 8687/W/S

ART. ITEM 5227/W- $\phi$ 16 mm

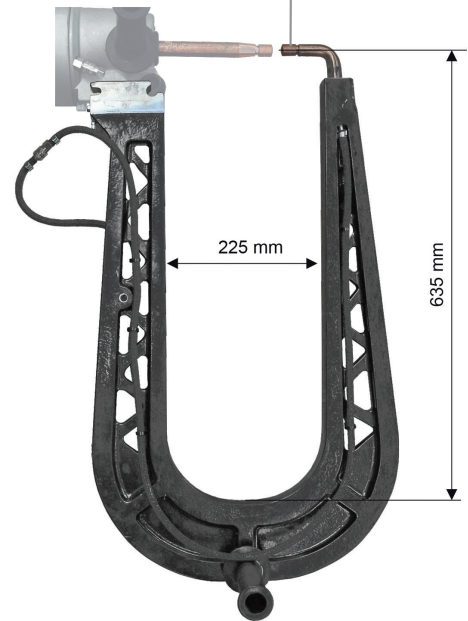

### ○ ART. ITEM 8688/W/S

ART. ITEM 5227/W- $\phi$ 16mm

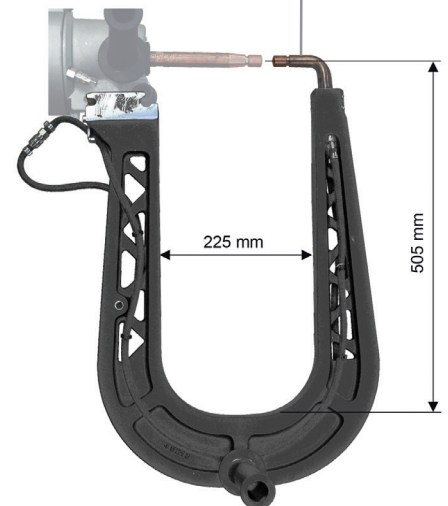

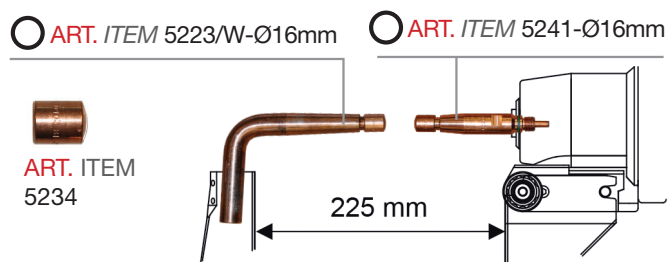
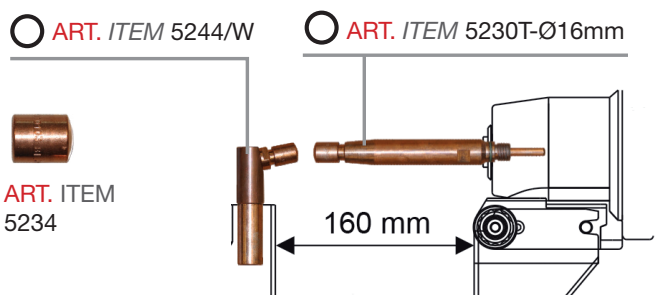
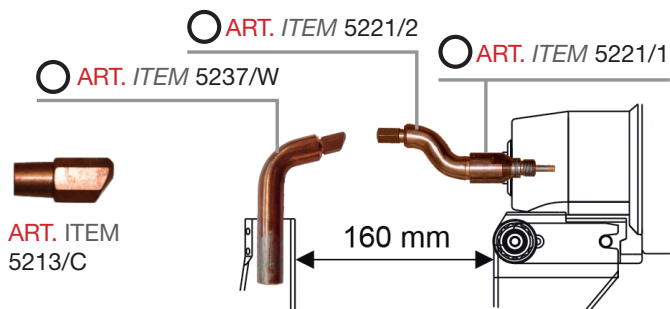
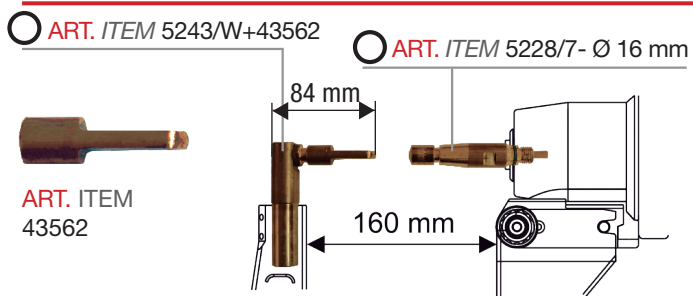
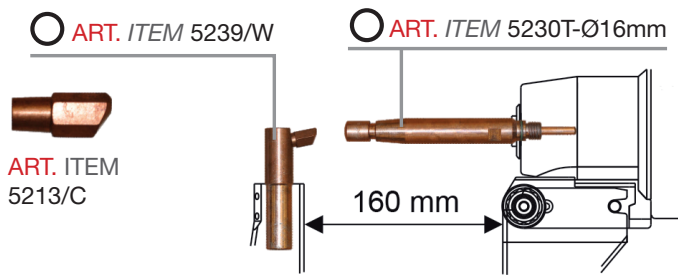
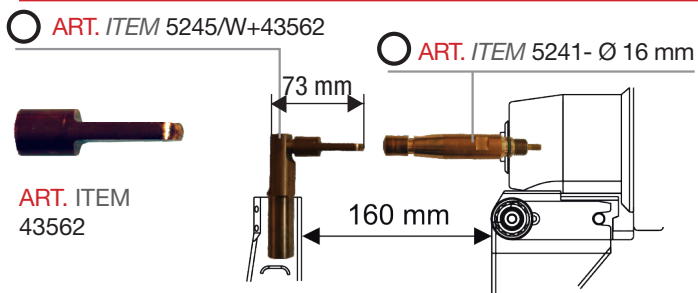
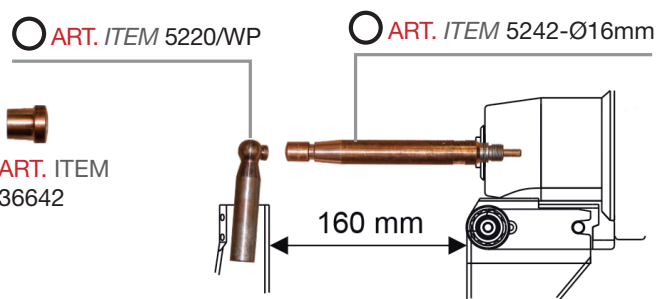
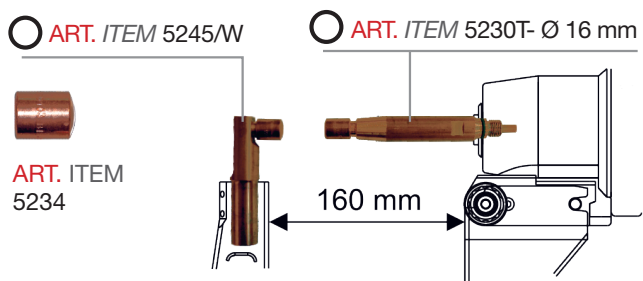
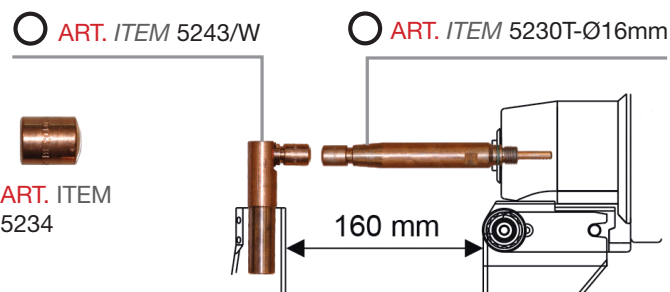
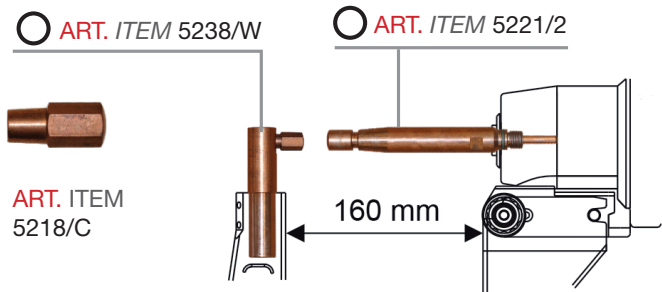
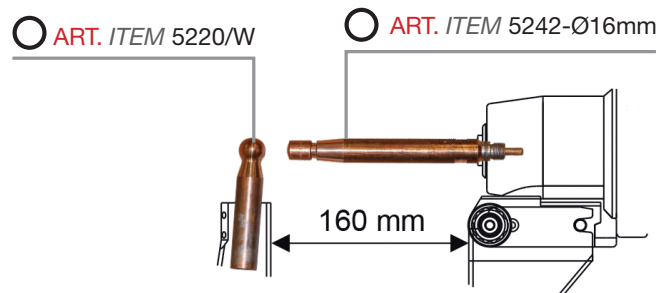
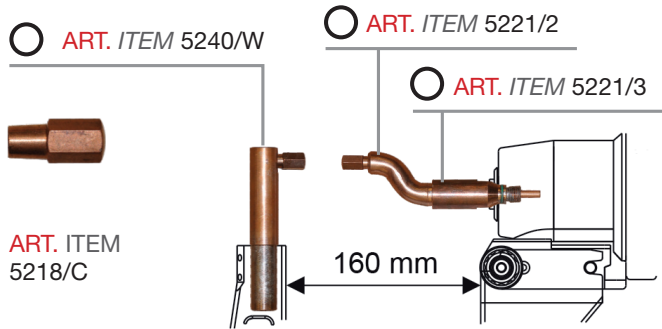

● STANDARD ○ A RICHIESTA - ON DEMAND

**SELEZIONE PACK**  
PACK SELECTION

**ART. ITEM 8680/PACK01**



**ART. ITEM 8688/W/S**

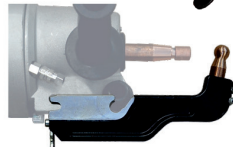

**ART. ITEM 8689**



**ART. ITEM 5223/W**



**ART. ITEM 5230T**



**ART. ITEM 5220/WP**

**ART. ITEM 8680/7/PACK01**



**ART. ITEM 8688/W/S**

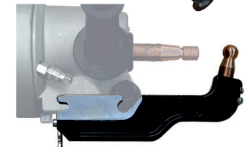

**ART. ITEM 8689**



**ART. ITEM 5223/W**



**ART. ITEM 5230/7**



**ART. ITEM 5220/WP**

**ART. ITEM 8680/PACK02**



**ART. ITEM 8686/W/S**



**ART. ITEM 5221/2**  
**ART. ITEM 5221/3**



**ART. ITEM 5240/W**

**ART. ITEM 8680/7/PACK02**



**ART. ITEM 8686/W/S**



**ART. ITEM 5221/2**  
**ART. ITEM 5221/7**



**ART. ITEM 5240/W**

**ACCESSORI**  
ACCESSORIES

**ART. ITEM 23221P**



PROGRAMMA SOFTWARE  
PENDRIVE SOFTWARE PROGRAM

**ART. ITEM 72000/3680**



**ART. ITEM 8691**



**ART. ITEM 8691/7**

**ART. ITEM 3591**



PISTOLA MULTIFUNZIONE  
MULTIFUNCTIONAL GUN



World leader  
in Resistance Welding

**TECNA**<sup>®</sup>

Via Meucci, 27  
40024 - Castel S. Pietro Terme (BO)  
Italy  
Tel. +39 051 695 4411  
Fax +39 051 695 4490  
[www.tecna.net](http://www.tecna.net)  
[vendite@tecna.net](mailto:vendite@tecna.net)  
[sales@tecna.net](mailto:sales@tecna.net)