

TECNA®

Via Grieco 25/27 - 40024 Castel S. Pietro Terme - (BO) - ITALY
Tel. +39.051.6954411 - Fax +39.051.6954490
<http://www.tecna.net> E-mail: sales@tecna.net

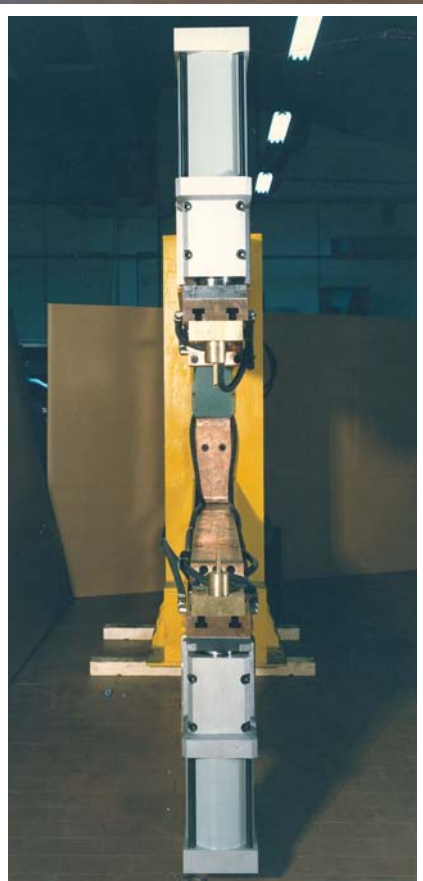
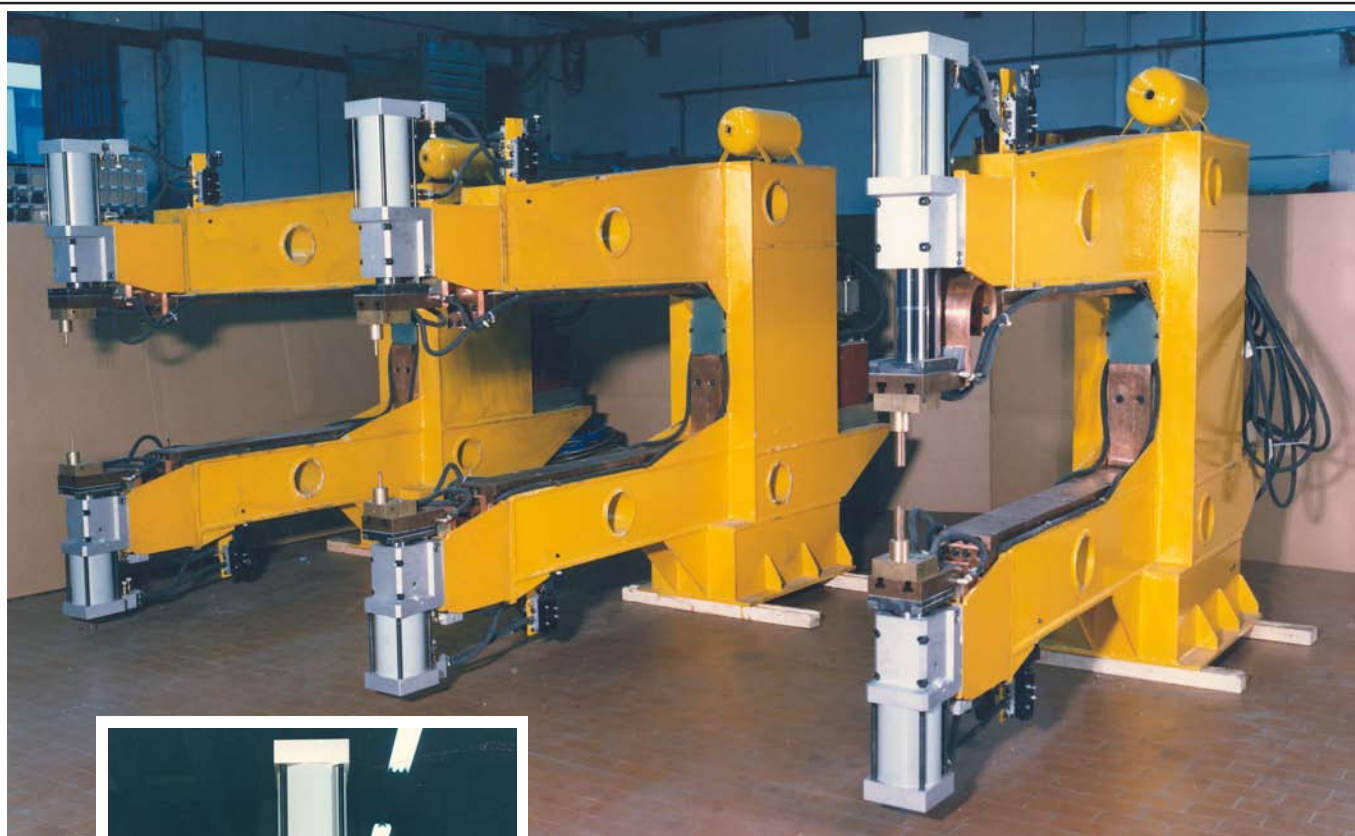

A richiesta si eseguono esecuzioni speciali:

- Diverse lunghezze dei bracci.
- Gruppi a discesa rettilinea con cilindro inferiore a corsa regolabile.
- Gruppi a discesa rettilinea in esecuzione a proiezione.
- Versioni con sensori di posizione sulla corsa dei cilindri.
- Versioni senza unità di controllo per impianti che richiedono controlli elettronici centralizzati.

Special executions upon demand:

- Different arms length.
- Linear action groups with adjustable stroke lower cylinder.
- Linear action groups in projection execution.
- Versions with position sensors on the cylinders stroke.
- Versions without control unit for installations requiring central control units.

TRIFASE DC - 250 kVA - 1885 daN - 100 kA

APPLICAZIONI SPECIALI • SPECIAL APPLICATIONS

TRIFASE CORRENTE CONTINUA - 50 Hz • THREEPHAS DIRECT CORRENT - 50 Hz
CORRENTE CONTINUA INVERTER M.F. - 1000 Hz • DIRECT CURRENT INVERTER M.F. - 1000 Hz

TECNA®

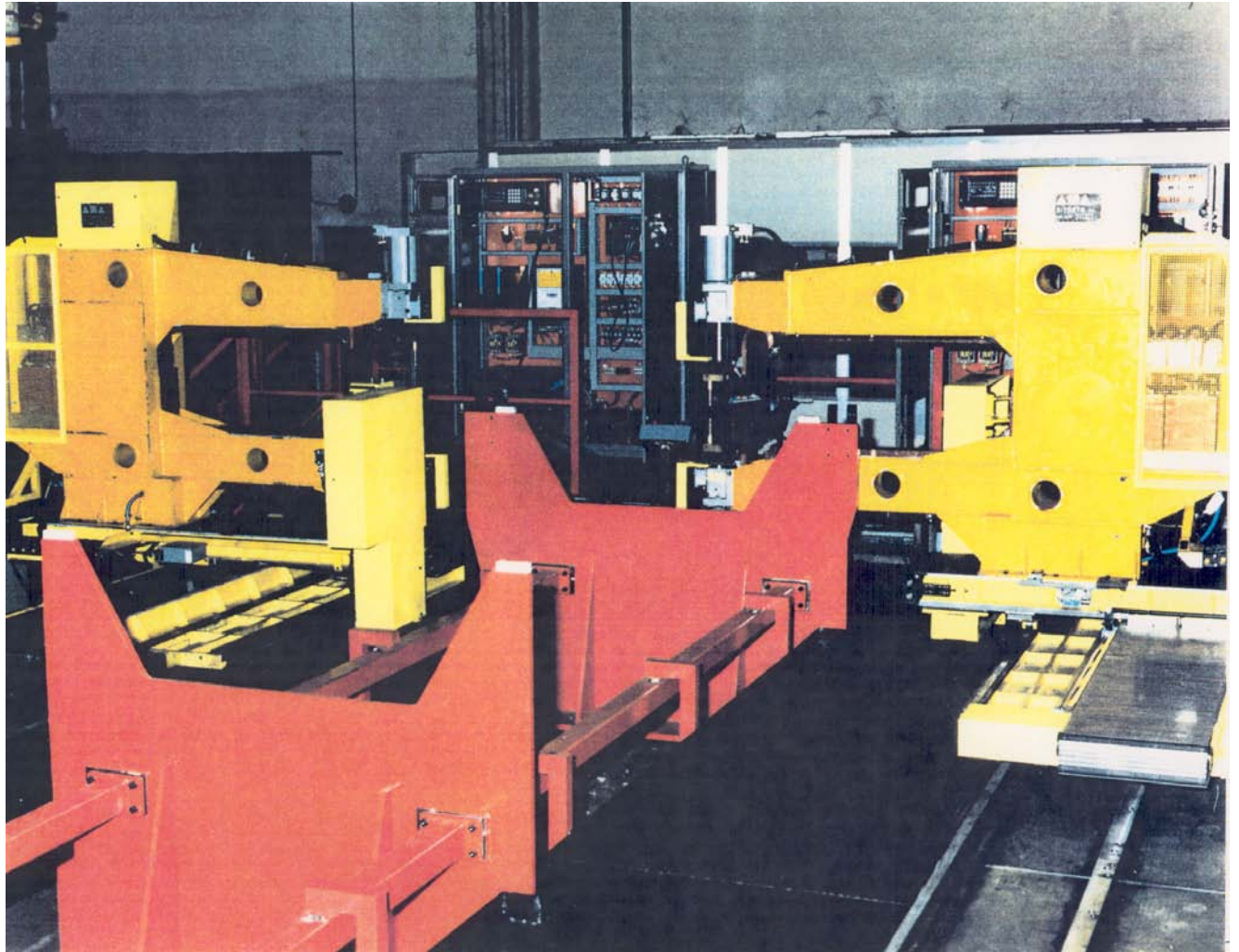

TECNA[®]

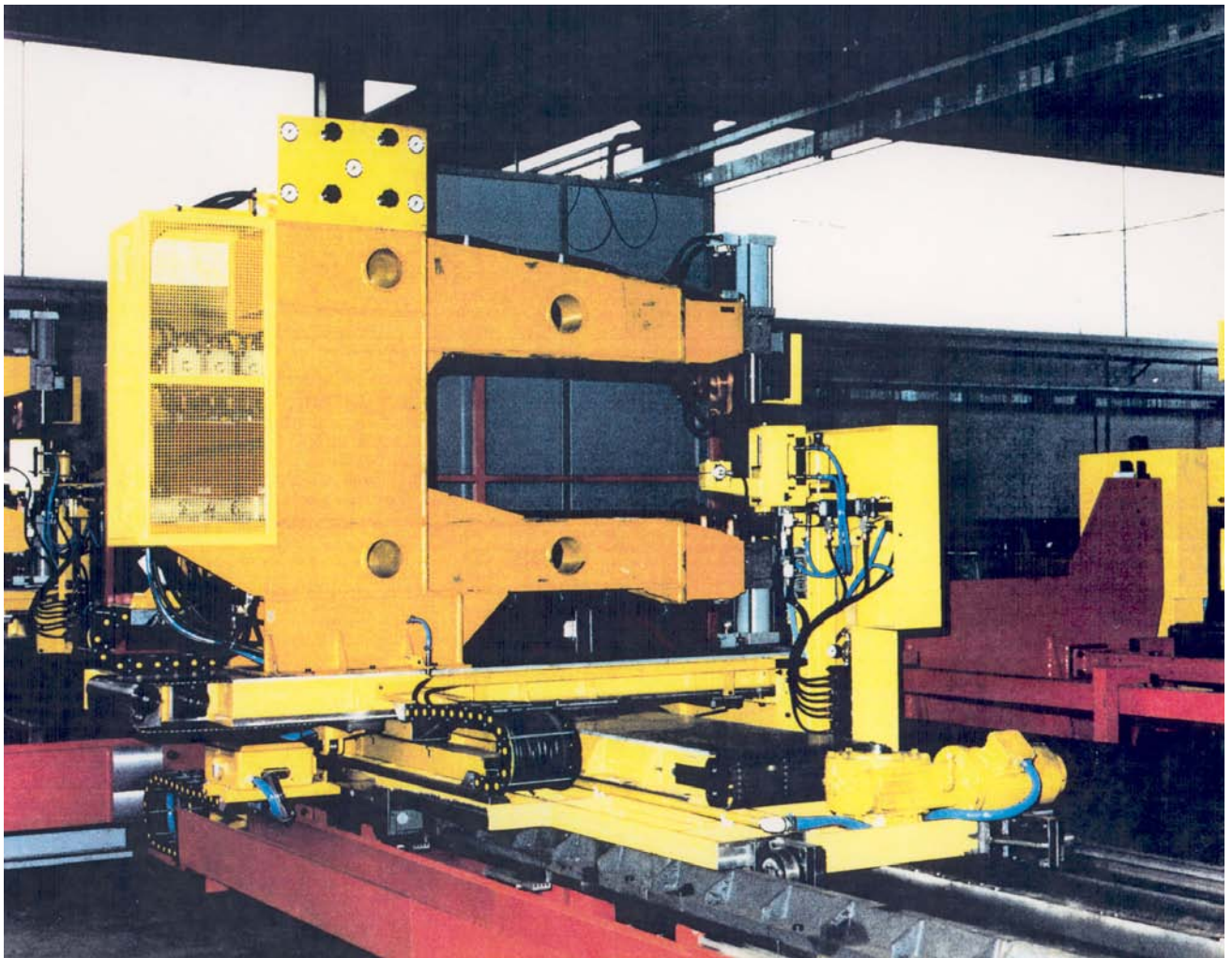

TECNA[®]

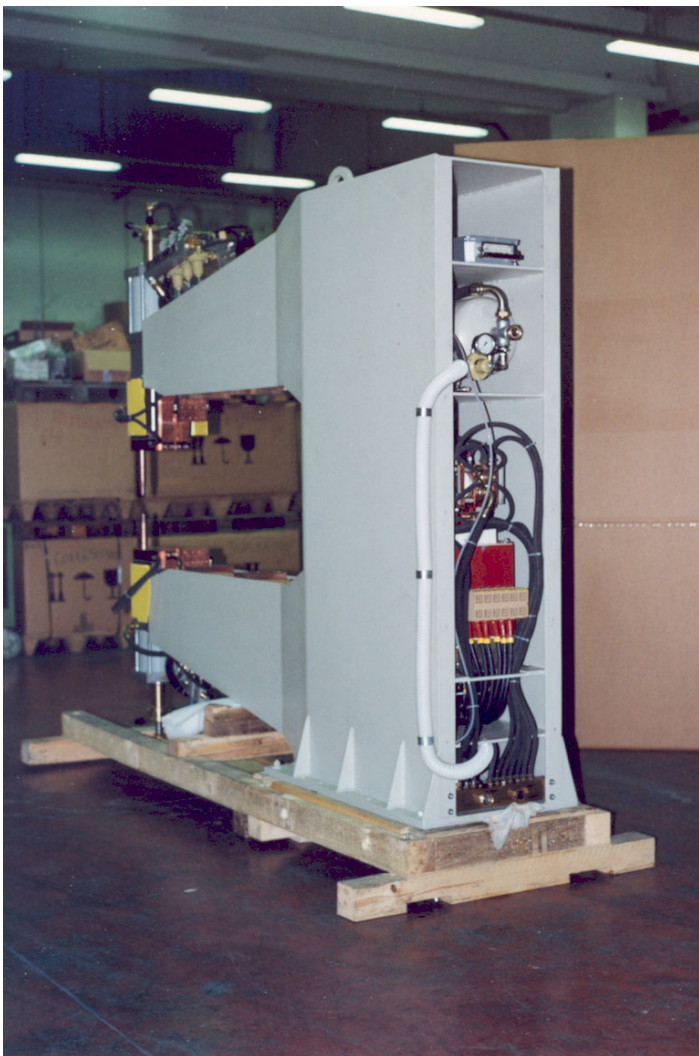
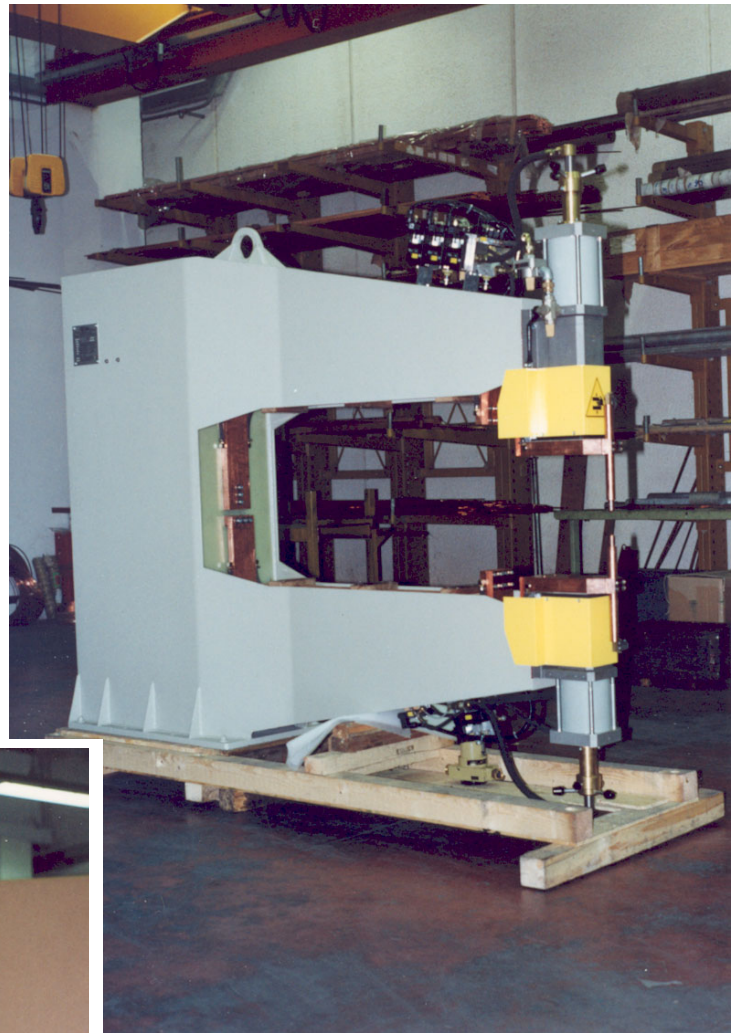

TRIFASE DC - 250 kVA - 1206 daN - 100 kA

TECNA[®]

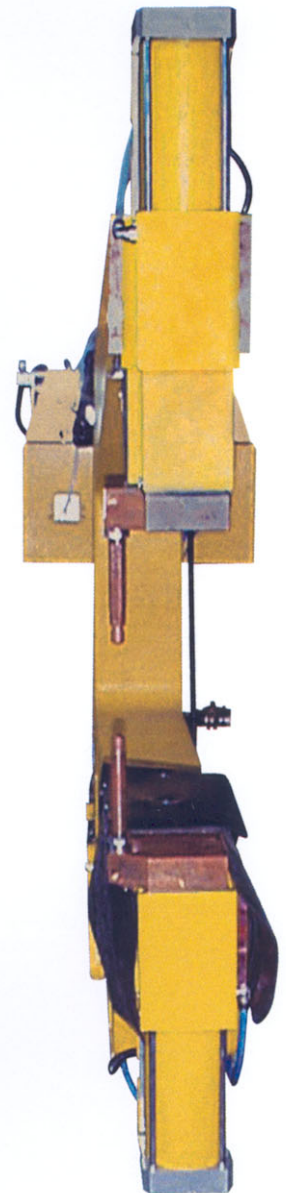
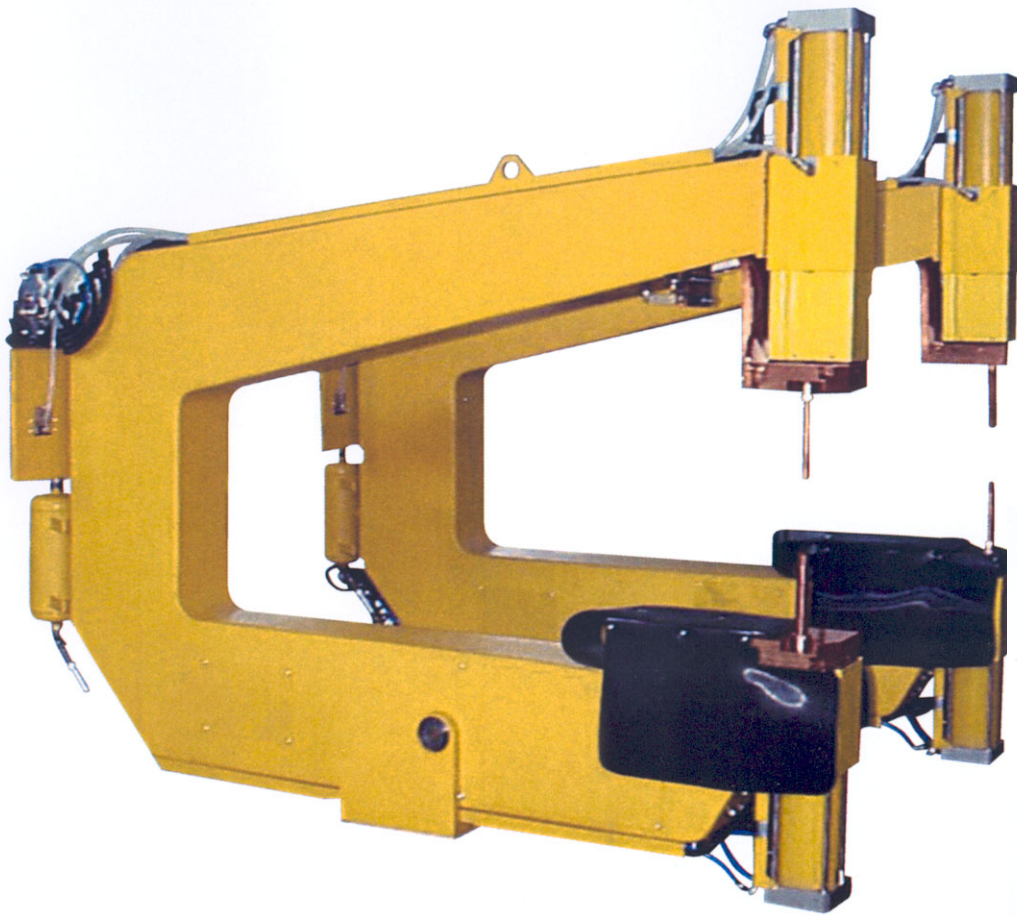

MF
3-PHASE
INVERTER

INVERTER M.F. - 180 kVA - 736 daN - 35 kA

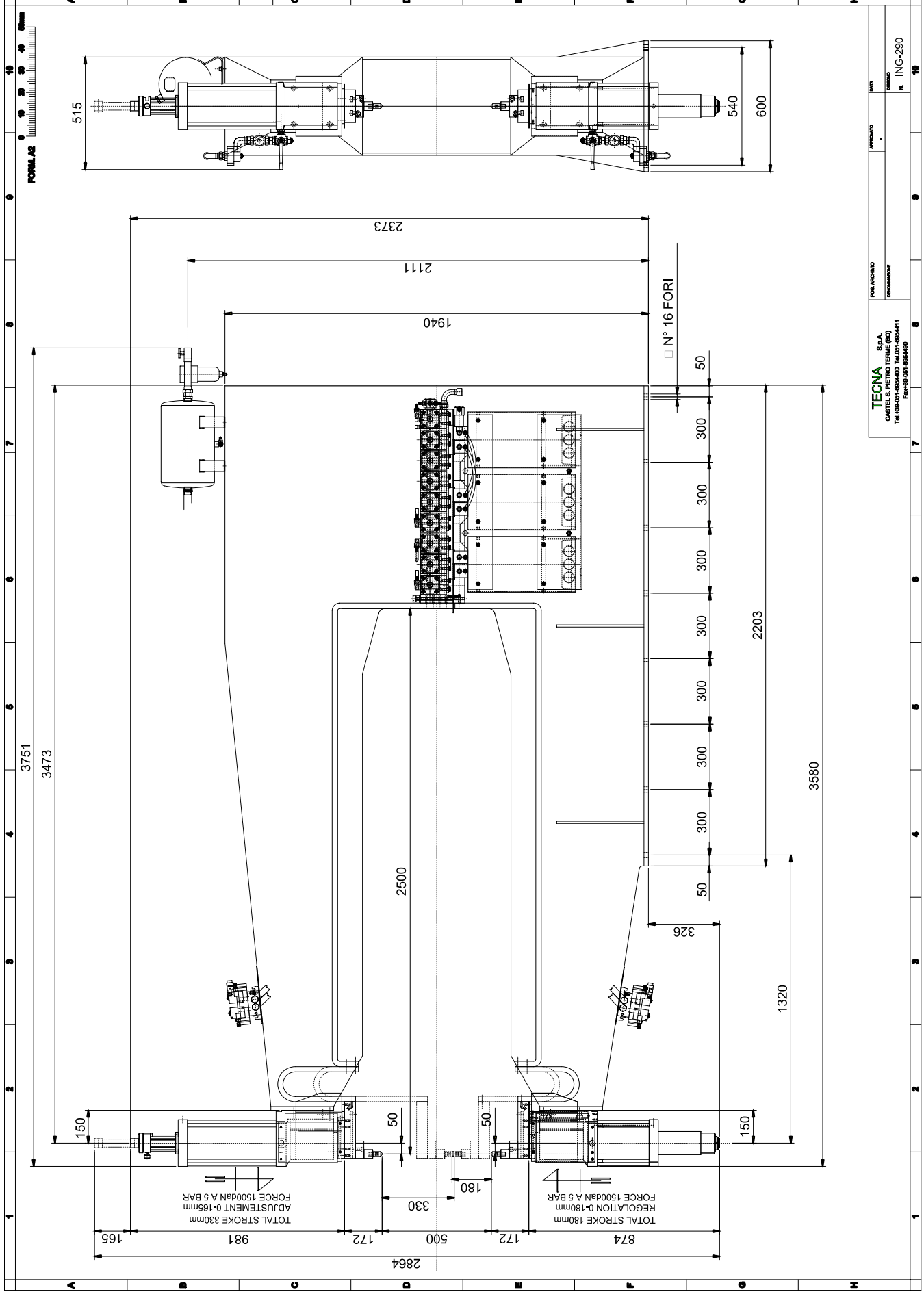

TECNA S.p.A.
 CASTEL S. PIETRO TERME (BO)
 Tel. +39 051 8064411
 Fax +39 051 8064400

FORNITORE
 N. ING-290

TRIFASE DC - 400 kVA - 1814 daN - 120 kA

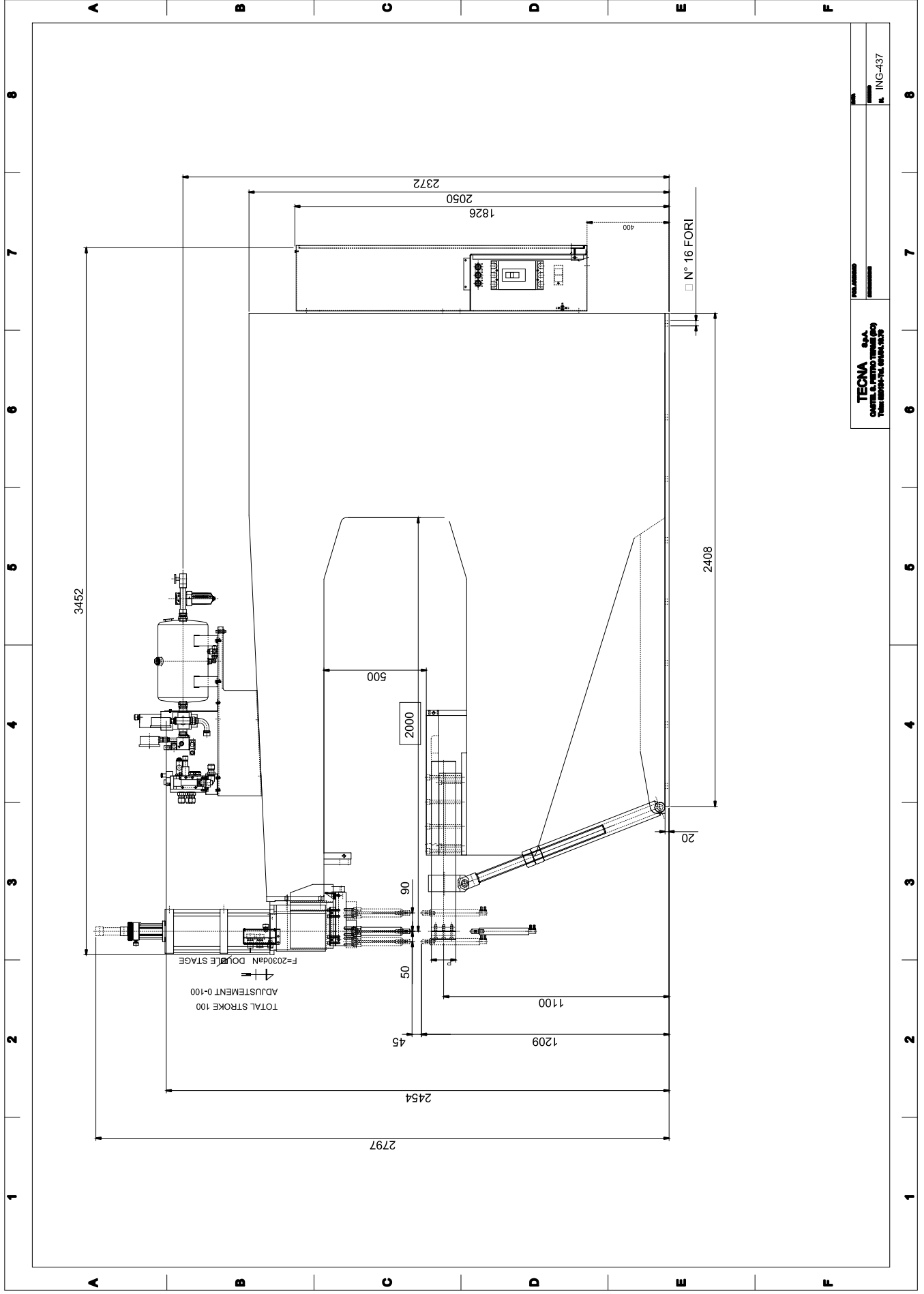

TECNA S.p.A. CENTRI & SERVIZI TECNICI Via Salaria 100 - 00198 Roma, Italia	
MODELLO ING-437	NUMERO 1

TRIFASE DC - 250 kVA - 2030 daN - 100 kA

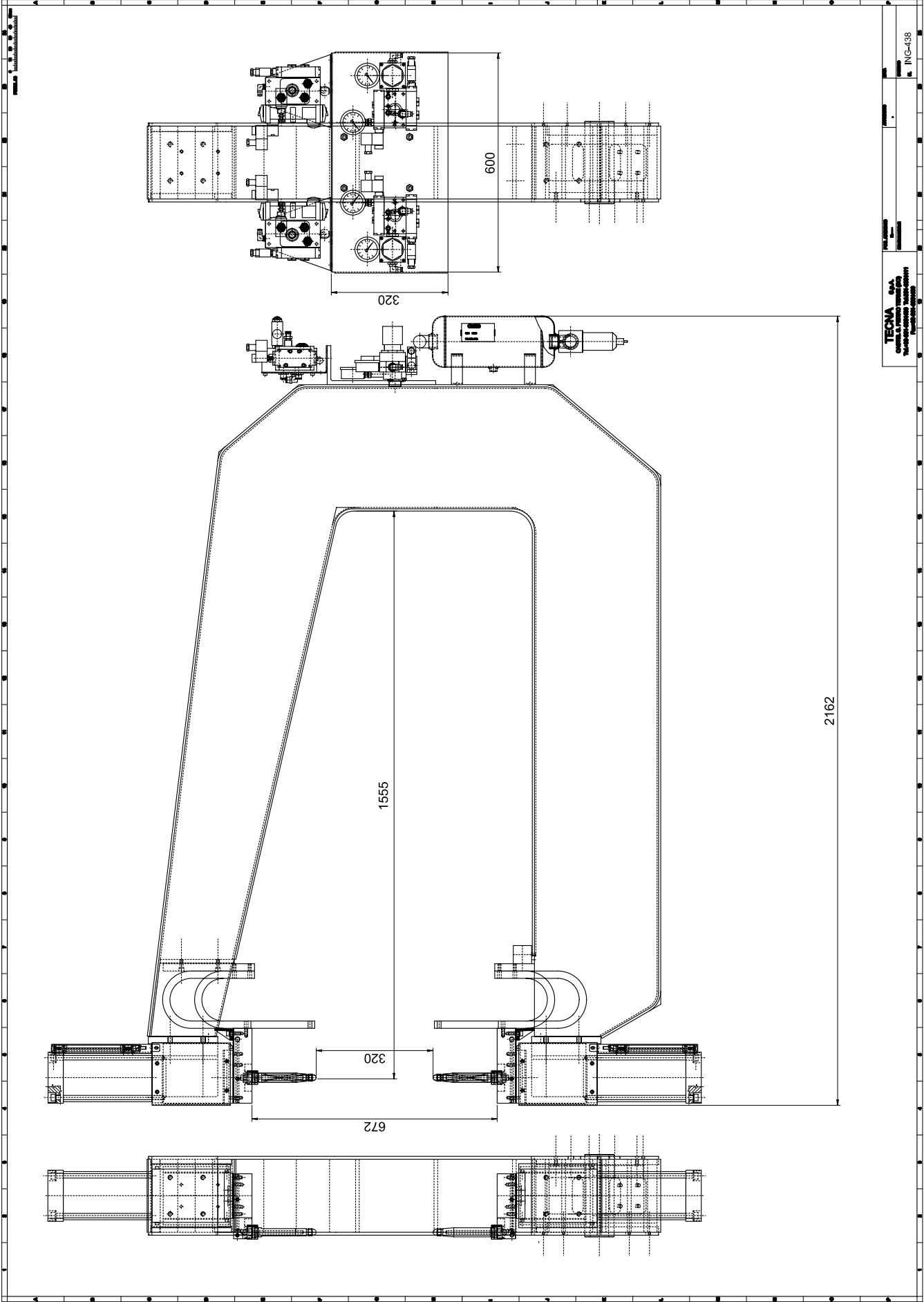

TECNA S.p.A. VIA S. PIERO, 10 - 37060 VERONA (VR) TEL. 0445/434111 - FAX 0445/434112		INC-438
---	--	---------

INVERTER M.F. - 180 kVA - 736 daN - 35 kA